

# T-CBN SERIES

www.tungaloy.com

Tungaloy Report No. 515-G

CBN with **WavyJoint** technology achieves stable machining of hardened steels



**INDUSTRY 4.0**  
*FEED the SPEED!*



ACCELERATED MACHINING



TurnLine

# T-CBN SERIES

TUNGALOY



**Robust as ever!** For outstanding performance in hard turning applications.

## For **high efficiency** hardened steel machining

### New brazing technology for increased machining efficiency - "WavyJoint"

- A maximum depth of cut up to 0.8 mm  
→ Reduces the number of passes to increase productivity
- Innovative WavyJoint brazing technology  
→ Prevents the CBN tips from debrazing, eliminating abrupt insert fractures during demanding dry machining, while securing stable and predictable hard turning operations.

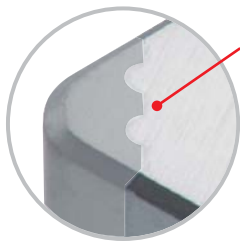

**Strong joint**

The "wavy" contact surface enhances the brazing strength.

4 cutting edges



### WavyJoint BXA20

**Vs.**

### Standard

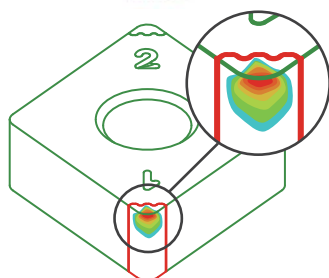
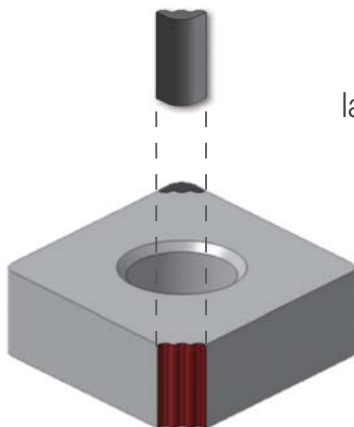

#### CBN tip size:

Using the cBN tip in a mass as large as **200x** provides increased thermal conductivity and helps reduce the temperature at the cutting edge

#### Brazing area:

Increased **160%** for enhanced brazing strength

Temperature during machining is concentrated on the CBN tip, reducing temperature issues in the brazing zone.

Workpiece material : SCM420 / 20CrMo4 (60HRC)  
Cutting speed :  $V_c = 150$  m/min  
Feed :  $f_z = 0.20$  mm/rev  
Depth of cut :  $a_p = 0.75$  mm  
Coolant : Dry

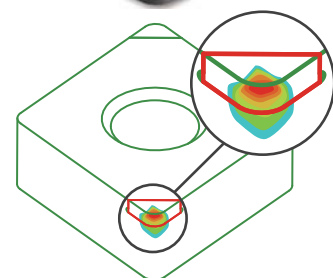
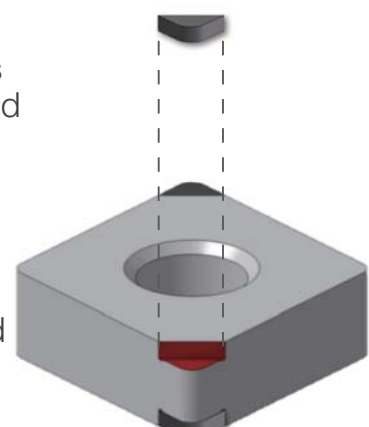

## APPLICATION

### Hard Turning

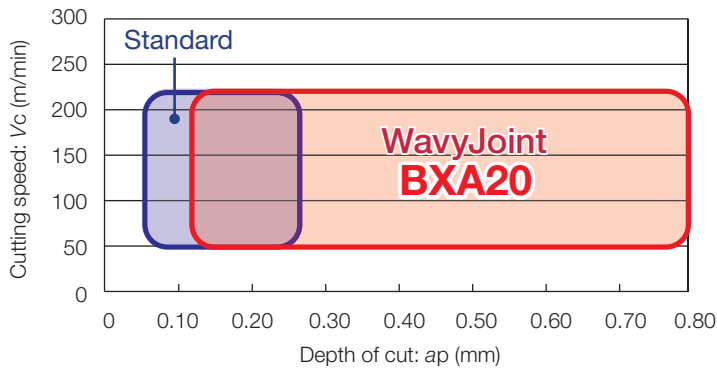

**H**

#### WavyJoint BXA20

Great performance for continuous to heavy interrupted cutting at low and medium speeds.

## CUTTING PERFORMANCE

### Effect of increased brazing area

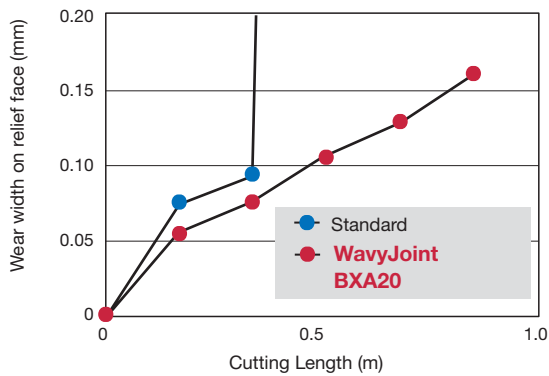

**H**

Insert : Standard = 2QP-CNGM12408-HM BXA20  
 WavyJoint = 4QS-CNGG120408-HM BXA20  
 Workpiece material : SCM420 / 20CrMo4 (60HRC) ø63 External turning  
 Cutting speed :  $V_c = 150$  m/min  
 Feed :  $f_z = 0.20$  mm/rev  
 Depth of cut :  $a_p = 0.75$  mm  
 Coolant : Dry





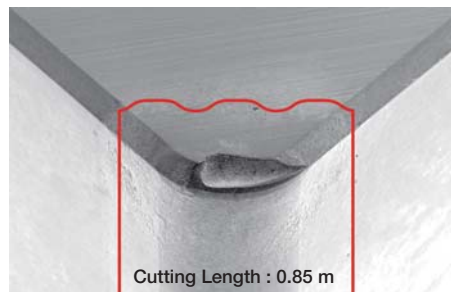





Standard

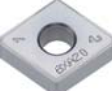

WavyJoint BXA20

The WavyJoint technology prevents the braze from overheating due to the increase in cutting edge temperature during dry cutting, greatly improving the brazing strength. The result: stable machining and extended tool life.

## INSERT

Feature	Shape	Designation	Grade	No. of corners	I. C. dia.	Thick-ness	Hole dia.	Corner radius	CBN length
			Coated						
			BXA20						
					IC	S	D1	RE	LE
Heavy horning		4QS-CNGA120408-H	●	4	12.7	4.76	5.16	0.8	1.5
		4QS-CNGA120412-H	●	4	12.7	4.76	5.16	1.2	1.7
With chipbreaker		4QS-CNGG120408-HM	●	4	12.7	4.76	5.16	0.8	1.5
		4QS-CNGG120412-HM	●	4	12.7	4.76	5.16	1.2	1.7
Heavy horning		4QS-DNGA150408-H	●	4	12.7	4.76	5.16	0.8	1.6
		4QS-DNGA150412-H	●	4	12.7	4.76	5.16	1.2	1.6
With chipbreaker		4QS-DNGG150408-HM	●	4	12.7	4.76	5.16	0.8	1.6
Heavy horning		6QS-TNGA160408-H	●	6	9.525	4.76	3.81	0.8	1.6
		6QS-TNGA160412-H	●	6	9.525	4.76	3.81	1.2	1.8
With chipbreaker		6QS-TNGG160408-HM	●	6	9.525	4.76	3.81	0.8	1.6
Heavy horning		4QS-VNGA160408-H	●	4	9.525	4.76	3.81	0.8	1.7
With chipbreaker		4QS-VNGG160408-HM	●	4	9.525	4.76	3.81	0.8	1.7
Heavy horning		6QS-WNGA080408-H	●	6	12.7	4.76	5.16	0.8	1.5

● : Line-up

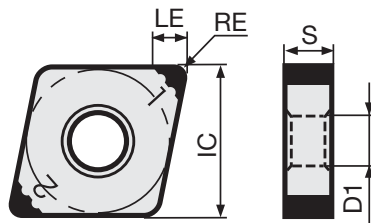

## STANDARD CUTTING CONDITIONS

ISO	Workpiece materials	Grade	Work condition	Cutting speed $V_c$ (m/min)	Depth of cut $a_p$ (mm)	Feed $f$ (mm/rev)
<b>H</b>	Hardened steel	BXA20	Continuous	50 - 220	0.12 - 0.80	0.10 - 0.30
		BXA20	Interrupted	50 - 200	0.12 - 0.80	0.10 - 0.20

## PRACTICAL EXAMPLES

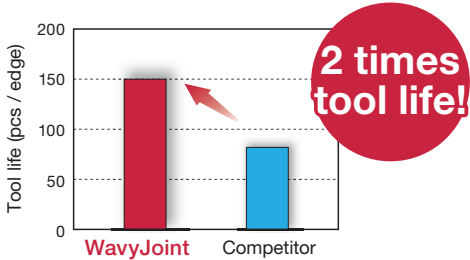
<b>Workpiece type</b>	<b>Automotive part</b>	
<b>Insert</b>	4QS-CNGA120412	
<b>Grade</b>	BXA20	
<b>Workpiece material</b>	SCM420 / 20CrMo4 (60HRC) <b>H</b>	
<b>Workpiece material</b>		
<b>Cutting conditions</b>	<b>Cutting speed : <math>V_c</math> (m/min)</b>	100
	<b>Feed : <math>f</math> (mm/rev)</b>	0.1 - 0.2
	<b>Depth of cut : <math>a_p</math> (mm)</b>	0.7 - 1.0
	<b>Coolant</b>	Dry
<b>Results</b>	 <p><b>2 times tool life!</b></p>	
	<p>The WavyJoint technology insert successfully machined 150 pcs/corner, almost twice that of the competitor's, without CBN tip failure.</p>	

## Tungaloy Corporation (Head office)

11-1 Yoshima-Kogyodanchi  
Iwaki-city, Fukushima, 970-1144 Japan  
Phone: +81-246-36-8501  
Fax: +81-246-36-8542  
www.tungaloy.co.jp

## Tungaloy America, Inc.

3726 N Ventura Drive  
Arlington Heights, IL 60004, U.S.A.  
Phone: +1-888-554-8394  
Fax: +1-888-554-8392  
www.tungaloyamerica.com

## Tungaloy Canada

432 Elgin St. Unit 3  
Brantford, Ontario N3S 7P7, Canada  
Phone: +1-519-758-5779  
Fax: +1-519-758-5791  
www.tungaloy.co.jp/ca

## Tungaloy de Mexico S.A.

C Los Arellano 113,  
Parque Industrial Siglo XXI  
Aguascalientes, AGS, Mexico 20290  
Phone: +52-449-929-5410  
Fax: +52-449-929-5411  
www.tungaloy.co.jp/mx

## Tungaloy do Brasil Ltda.

Avd. Independencia N4158 Residencial Flora  
13280-000 Vinhedo, São Paulo, Brasil  
Phone: +55-19-38262757  
Fax: +55-19-38262757  
www.tungaloy.com.br

## Tungaloy Germany GmbH

An der Alten Ziegelei 1  
D-40789 Monheim, Germany  
Phone: +49-2173-90420-0  
Fax: +49-2173-90420-19  
www.tungaloy.de

## Tungaloy France S.A.S.

ZA Courtaboef - Le Rio  
1 rue de la Terre de feu  
F-91952 Courtaboef Cedex, France  
Phone: +33-1-6486-4300  
Fax: +33-1-6907-7817  
www.tungaloy.fr

## Tungaloy Italia S.r.l.

Via E. Andolfato 10  
I-20126 Milano, Italy  
Phone: +39-02-252012-1  
Fax: +39-02-252012-65  
www.tungaloy.it

## Tungaloy Czech s.r.o.

Turanka 115  
CZ-627 00 Brno, Czech Republic  
Phone: +420-532 123 391  
Fax: +420-532 123 392  
www.tungaloy.cz

## Tungaloy Ibérica S.L.

C/Miquel Servet, 43B, Nau 7  
Pol. Ind. Bufalvent  
ES-08243 Manresa (BCN), Spain  
Phone: +34 93 113 1360  
Fax: +34 93 876 2798  
www.tungaloy.es

## Tungaloy Scandinavia AB

Bultgatan 38  
442 40 Kungälv, Sweden  
Phone: +46-462119200  
www.tungaloy.se

## Tungaloy Rus, LLC

115432, Russian Federation, Moscow,  
Andropova avenue., h.18, bld.7, flt. 11,  
office 3.  
Phone: +7-499-683-01-80/81  
www.tungaloy.co.jp/ru

## Tungaloy East LLC

620075, Russian Federation, Sverdlovsk  
Region, Ekaterinburg, Mamina-Sibiryaka str.,  
bldg. 101, room 202  
Phone: +7-343-286-48-23/24  
Fax: +7-912-284-91-69  
www.tungaloy.co.jp/ru

## Tungaloy Polska Sp. z o.o.

ul. Genewska 24  
03-963 Warszawa, Poland  
Phone: +48-22-617-0890  
Fax: +48-22-617-0890  
www.tungaloy.co.jp/pl

## Tungaloy U.K. Ltd

The Technology Centre,  
Wolverhampton Science Park  
Glaisher Drive, Wolverhampton  
West Midlands WV10 9RU, UK  
Phone: +44 121 4000 231  
Fax: +44 121 270 9694  
www.tungaloy.co.jp/uk  
salesinfo@tungaloyuk.co.uk

## Tungaloy Hungary Kft

Erzsébet királyné útja 125  
H-1142 Budapest, Hungary  
Phone: +36 1 781-6846  
Fax: +36 1 781-6866  
www.tungaloy.co.jp/hu  
info@tungaloytools.hu

## Tungaloy Turkey

Dudullu, OSB 4. Cad No:4  
34776 Umraniye Istanbul, TURKEY  
Phone: +90 216 540 04 67  
Fax: +90 216 540 04 87  
www.tungaloy.com.tr  
info@tungaloy.com.tr

## Tungaloy Benelux b.v.

Tjalk 70  
NL-2411 NZ Bodegraven, Netherlands  
Phone: +31 172 630 420  
Fax: +31 172 630 429  
www.tungaloy-benelux.com

## Tungaloy Croatia

Josipa Kozarca 4  
10432 Bregana, Croatia  
Phone: +385 1 3326 604  
Fax: +385 1 3327 683  
www.tungaloy.hr

## Tungaloy Cutting Tool (Shanghai) Co., Ltd.

Rm No 401 No.88 Zhabei  
Jiangchang No.3 Rd  
Shanghai 200436, China  
Phone: +86-21-3632-1880  
Fax: +86-21-3621-1918  
www.tungaloy.co.jp/tots

## Tungaloy Cutting Tool (Thailand) Co., Ltd.

Interlink tower 4th Fl.  
1858/5-7 Bangna-Trad Road  
km.5 Bangna, Bangna, Bangkok 10260  
Thailand  
Phone: +66-2-751-5711  
Fax: +66-2-751-5715  
www.tungaloy.co.th

## Tungaloy Singapore (Pte.), Ltd.

62 Ubi Road 1, #06-11 Oxley BizHub 2  
Singapore 408734  
Phone: +65-6391-1833  
Fax: +65-6299-4557  
www.tungaloy.co.jp/tspl

## Tungaloy Vietnam

LE 04-38, Lexington Residence  
67 Mai Chi Tho, Dist. 2,  
Ho Chi Minh City, Vietnam  
Phone: +84-8-37406660  
Fax: +84-8-37406662  
www.tungaloy.co.jp/tspl

## Tungaloy India Pvt. Ltd.

Indiabulls Finance Centre,  
Unit # 902-A, 9th Floor,  
Tower 1, Senapati Bapat Marg,  
Elphinstone Road (West),  
Mumbai -400013, India  
Phone: +91-22-6124-8804  
Fax: +91-22-6124-8899  
www.tungaloy.co.jp/in

## Tungaloy Korea Co., Ltd

#1312, Byucksan Digital Valley 5-cha  
Beotkot-ro 244, Geumcheon-gu  
153-788 Seoul, Korea  
Phone: +82-2-2621-6161  
Fax: +82-2-6393-8952  
www.tungaloy.co.jp/kr

## Tungaloy Malaysia Sdn Bhd

50 K-2, Kelana Mall, Jalan SS6/14  
Kelana Jaya, 47301  
Petaling Jaya, Selangor Darul Ehsan  
Malaysia  
Phone: +603-7805-3222  
Fax: +603-7804-8563  
www.tungaloy.co.jp/my

## Tungaloy Australia Pty Ltd

PO Box 2232, Rowville,  
Victoria 3178, Australia  
Phone: +61-3-9755-8147  
Fax: +61-3-9755-6070  
www.tungaloy.com.au

## PT. Tungaloy Indonesia

Kompleks Grand Wisata Block AA-10 No.3-5  
Cibitung  
Bekasi 17510, Indonesia  
Phone: +62-21-8261-5808  
Fax: +62-21-8261-5809  
www.tungaloy.co.jp/id



www.tungaloy.com

follow us at:

facebook.com/tungaloyjapan

twitter.com/tungaloyjapan

To see this product in action visit:

# Tung-TV

www.youtube.com/tungaloycorporation

Distributed by:



DOWNLOAD  
Dr. Carbide App



FIND US ON THE CLOUD!  
machiningcloud.com



Available on the  
App Store



GET IT ON  
Google play



AS9100 Certified  
78006  
2015.11.04  
ISO14001 Certified  
EC97J1123  
1997.11.26

Produced from Recycled paper

Jun. 2018 (TJ)